

**Simply Windows & Doors
(Southern) Limited**

Windows | Doors | UPVC | Aluminium



Pioneering Service, Quality and Security



Contents

Features and benefits of Rustique & System 10	4
UPVC	
Casement Windows	6
Flush Sash Windows	8
Tilt & Turn Windows	10
Vertical Sliding Sash Windows	12
Fully Reversible Windows	14
French and Residential Doors	16
Patio Doors	18
DoorCo	20
Palladio	22
Aluminium	
Heritage Windows (58BW ST)	24
Tilt Before Turn Windows (58BW TBT)	26
Casement Windows (58BW)	28
Flush Sash Windows (58BW Flush)	30
Commercial Shopfronts (GT55 NI/TB)	32
Bifold Doors BSF70	34
Patio Doors BSC94	36
Residential and French Doors (58BD)	38
Hardware	40
The HI System	42
Installer's Guide to Part L	43
Kubu	44

Rustique

1 Chambers

Five fully enclosed chambers with an increased wall thickness offer additional product strength, rigidity and performance in addition to improved thermal efficiency.

2 Reinforcement chamber

The additional chamber enables galvanised steel reinforcement to be used for greater strength and rigidity.

3 Single leg bead for quick and easy glazing

Our single leg bead has a simple 'knock-in' design that is fitter friendly and will make glazing on site quick, easy and more positive. The single leg bead provides a performance to BS7950 Security enhancement standards.

4 PCE gasket

Our PCE low level gasket allows quicker fabrication and installation. The heat bonded gasket means that there is no shrinkage or any risk of the incorrect gasket being fitted. It gives a consistency in quality and finish, which reduces any hard lumps in corners and overcomes any stretching problems. It features a new weather seal flipper and 3.0mm glazing pad for an improved seal.

5 Low level gasket

Our PCE gaskets are low level, which means they are designed to fit in with the profile so that the maximum glass area is made visible with no unsightly gasket lines.

6 Drainage

A wider drainage channel allows for quick draining of any water/residue build up for an improved performance.

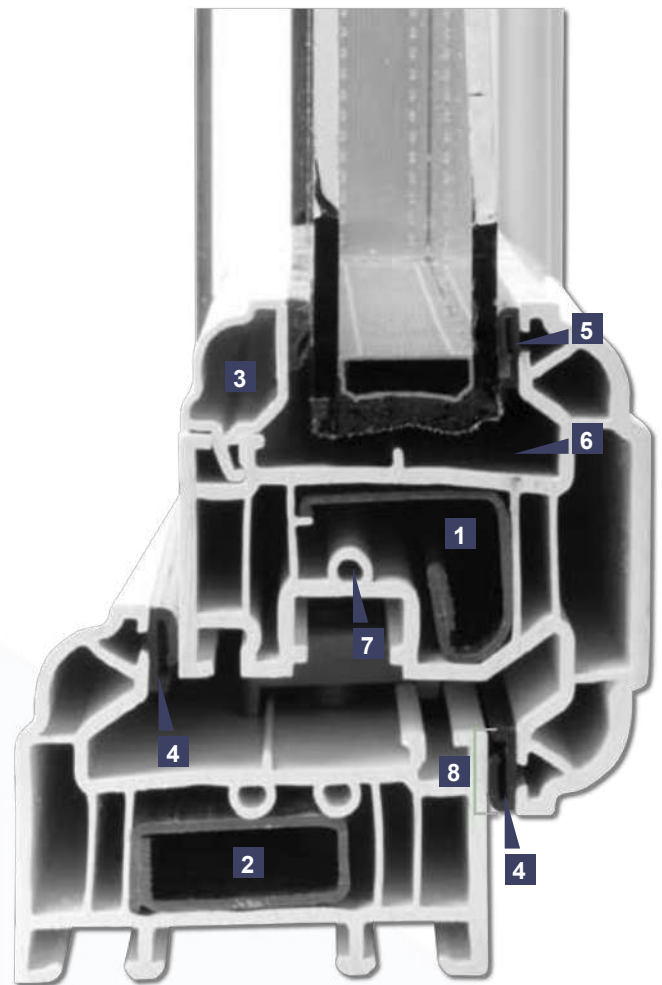

(P10638 Sash shown)

7 Top hat fixings and screw ports

Hardware and striker keeps are screwed into top hat fixing points and screw ports for an improved technical and enhanced security performance.

8 10mm overlap

A 10mm overlap as standard gives an increased weather performance.

Our systems have a simple 'clip on' feature for the easy fitting of frame extensions, sills and ancillaries without the need for screw fixings. Most leading brands of hardware are compatible with our systems.

System 10

1 Chambers

Fully enclosed chambers (four for the sash and three for the frame) with increased wall thicknesses offer additional product strength, rigidity and performance in addition to improved thermal efficiency.

2 Reinforcement chamber

The additional chamber enables galvanised steel reinforcement to be used for greater strength and rigidity (image shows thermal outerframe sleeve).

Our unique reinforcement design ensures optimum strength and rigidity without compromising thermal efficiency.

3 Single leg bead for quick and easy glazing

Our single leg bead has a simple 'knock-in' design that is fitter friendly and will make glazing on site quick, easy and more positive. The single leg bead has been tested to BS7950, for enhanced Security standards.

4 PCE gasket

Our PCE low level gasket allows quicker fabrication and installation. The heat bonded gasket means there is no shrinkage or any risk of the incorrect gasket being fitted. It gives consistency in quality and finish, overcomes any stretching problems and maximises compression. The special design for the gasket channel reduces the risk of hard lumps in corners and allows for the replacement of gaskets in case of damage. It features a new weather seal flipper and a glazing pad for an improved seal.

5 Low level gasket

Our PCE gaskets are low level, which means they are designed to fit in with the profile so that the maximum glass area is made visible with no unsightly gasket lines.

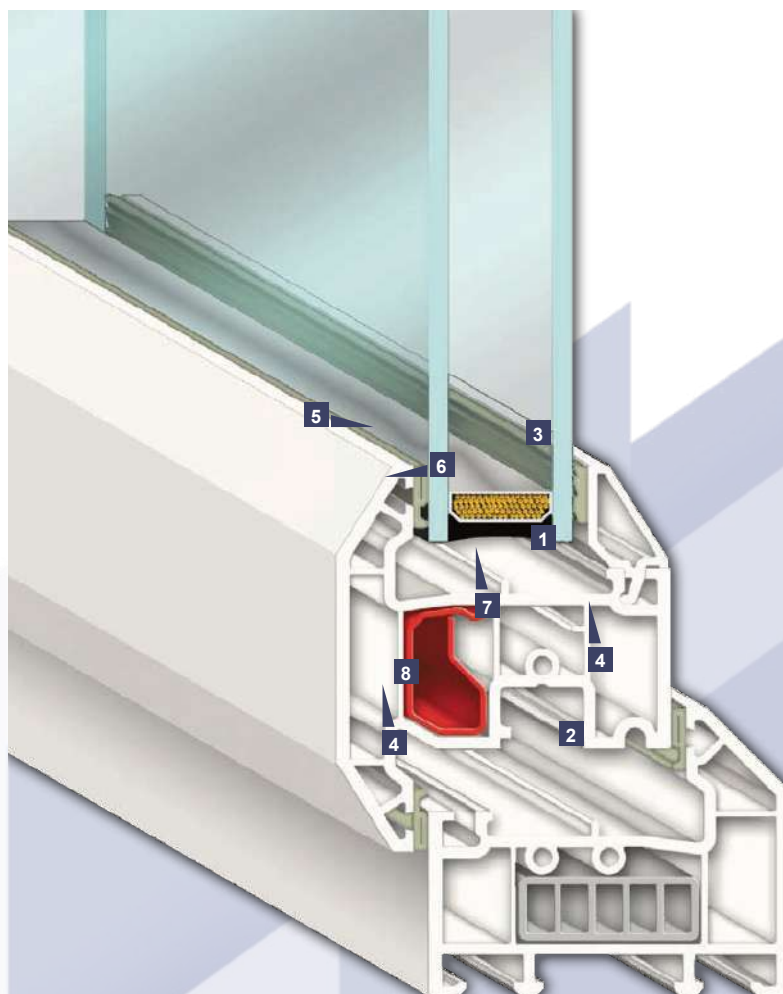

6 Drainage

A wider drainage channel allows for quick drainage of any water and reduced risk of residue build up for an improved performance.

7 Top hat fixings and screw ports

Hardware and striker keeps are screwed into top hat fixing points and screw ports for an improved technical and enhanced security performance. The system has been tested to PAS024 security standard.

8 10mm overlap

A 10mm overlap as standard gives an increased weather performance.

UPVC Casement Windows

Casement windows are among the most versatile of all the systems we manufacture from our base in Portsmouth, Hampshire. We can create an outward opening window in almost any configuration, ranging from fixed frames to wider bow and bay sets. Whatever your requirement, it can be manufactured by Window Warehouse for you.

- 7-10 day lead time on stock colours and standard foil profiles.
- Available in fully **chamfered** and **fully sculptured** profiles.
- **Thermally efficient** profile with a U-value as low as 1.1 W/m²K when triple glazed and 1.4W/m²K when double glazed.
- Options for top and side hung layout alongside a **70mm profile**.
- PAS 24 and Doc Q approved security available upon request.



White	Cream	Chartwell Green	Pebble Grey	Agate Grey	Silver Grey	
Slate Grey	Anthracite Grey	Anthracite Grey Smooth	Beck Brown	Irish Oak	Golden Oak	Rosewood

Can't find the colour you are looking for? Ask your sales representative for further options.

UPVC Flush Sash Windows

- 10-14 day lead time on standard foil profiles.
- 70mm uPVC profile with outer frame in either 56mm or 72mm.
- Multi point locking for a secure and protected home.
- Thermally efficient profile with a U-value as low as 1.4W/m²K when double glazed and 1.1 W/m²K with specialised glass options.





White	Cream	Chartwell Green	Pebble Grey	Agate Grey	Basalt Grey	Silver Grey
Slate Grey	Anthracite Grey	Anthracite Grey Smooth	Beck Brown	Irish Oak	Golden Oak	Rosewood

Can't find the colour you are looking for? Ask your sales representative for further options.

UPVC Tilt & Turn Windows

- 28mm to 36mm glazing beads available as standard.
- Our tilt and turn windows have a 72mm uPVC profile.
- Thermally efficient, these windows can achieve U-values of just 1.1W/m²K.
- Safe and secure with multi-point locking included.



White	Cream	Chartwell Green	Pebble Grey	Agate Grey	Silver Grey
-------	-------	-----------------	-------------	------------	-------------

Slate Grey	Anthracite Grey	Anthracite Grey Smooth	Beck Brown	Irish Oak	Golden Oak	Rosewood
------------	-----------------	------------------------	------------	-----------	------------	----------

Can't find the colour you are looking for? Ask your sales representative for further options.

UPVC Vertical Sliding Windows

- **4-5 week lead time** on standard and foil profiles.
- Sculptured profile for heritage and elegant feel.
- Smooth and woodgrain finishes available.
- Option to add external and internal georgian bars and a deep bottom rail.
- U-values as low as 1.4W/m²K when double glazed.
- 66mm mid rail
- Tilting sashes for simple cleaning.
- Mechanical joints as standard, optional welded joints.

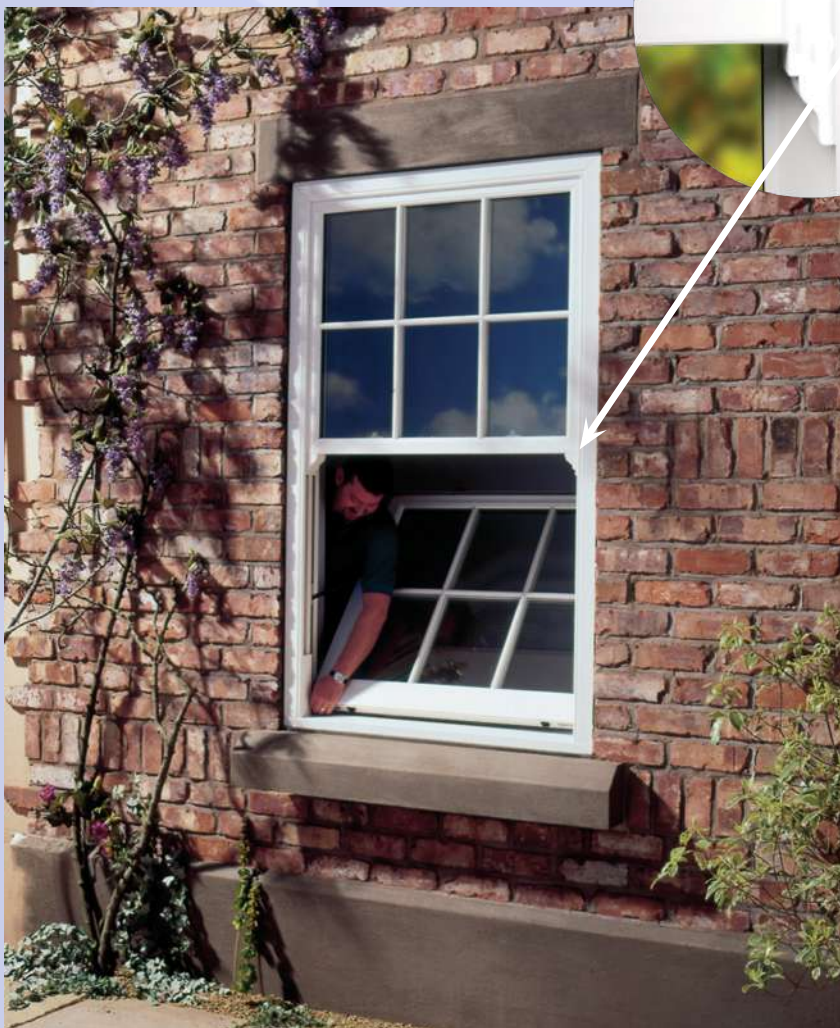

Run-through horns as standard.



White	Cream	Chartwell Green	Pebble Grey	Agate Grey	Silver Grey
-------	-------	-----------------	-------------	------------	-------------

Slate Grey	Anthracite Grey	Anthracite Grey Smooth	Beck Brown	Irish Oak	Golden Oak	Rosewood
------------	-----------------	------------------------	------------	-----------	------------	----------

Can't find the colour you are looking for? Ask your sales representative for further options.

UPVC Fully Reversible Windows

- 68mm reversible sash
- Glazing Beads: 28mm sculptured, 28mm bevelled, 32mm sculptured, 32mm bevelled, 36mm bevelled.
- U-Values as low as 1.4W/m²K.

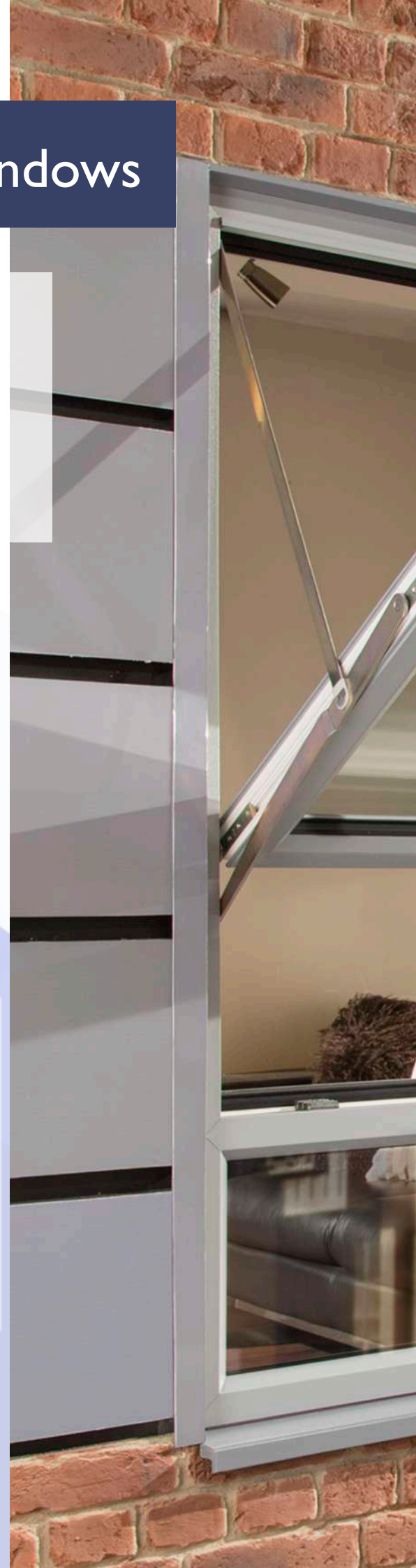



White	Cream	Chartwell Green	Pebble Grey	Agate Grey	Basalt Grey	Silver Grey
Slate Grey	Anthracite Grey	Anthracite Grey Smooth	Beck Brown	Irish Oak	Golden Oak	Rosewood

Can't find the colour you are looking for? Ask your sales representative for further options.

UPVC French and Residential Doors



- Fully configurable uPVC French and Residential door designs.
- Brochures, guides and videos all available from Window Warehouse.
- Security assured for your homeowners.
- We promote quick and transparent pricing on our doors.
- PAS 24 and Doc Q approved security available upon request.



Fitted with Kubu

- No additional work at the point of installation.
- Gain more sales by offering smart home Technology.
- Gain access to free homeowner leads from Kubu.
- Simple, fast and easy set up for homeowners.



Can't find the colour you are looking for? Ask your sales representative for further options.

UPVC Patio Doors

Configurations

Width Range:

Minimum Maximum

1600mm 3000mm

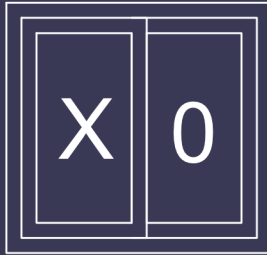

2400mm 4000mm

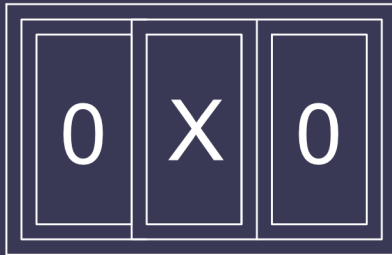

2400mm 4000mm

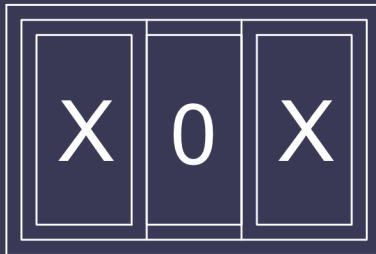

3000mm 5000mm

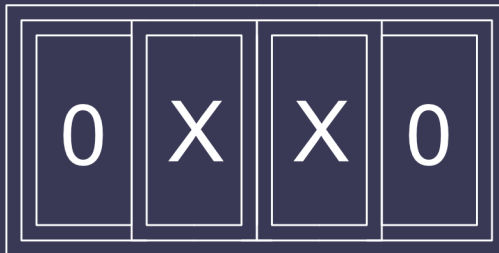

Height Range (All styles):

Threshold Minimum Maximum

 105178	2000mm	2400mm
 104324	1965mm	2365mm

- Concealed drainage and double wool piping for improved weather proofing.
- Mid rail with letter plate available on our uPVC patio doors.
- Slim stepped 70mm outer frame to reduce plaster cutback.
- Welded or mechanical outer frame option.
- 2/3/4 pane options for your homeowner's sliding doors.

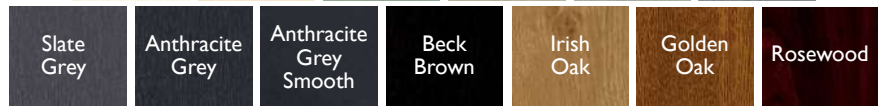
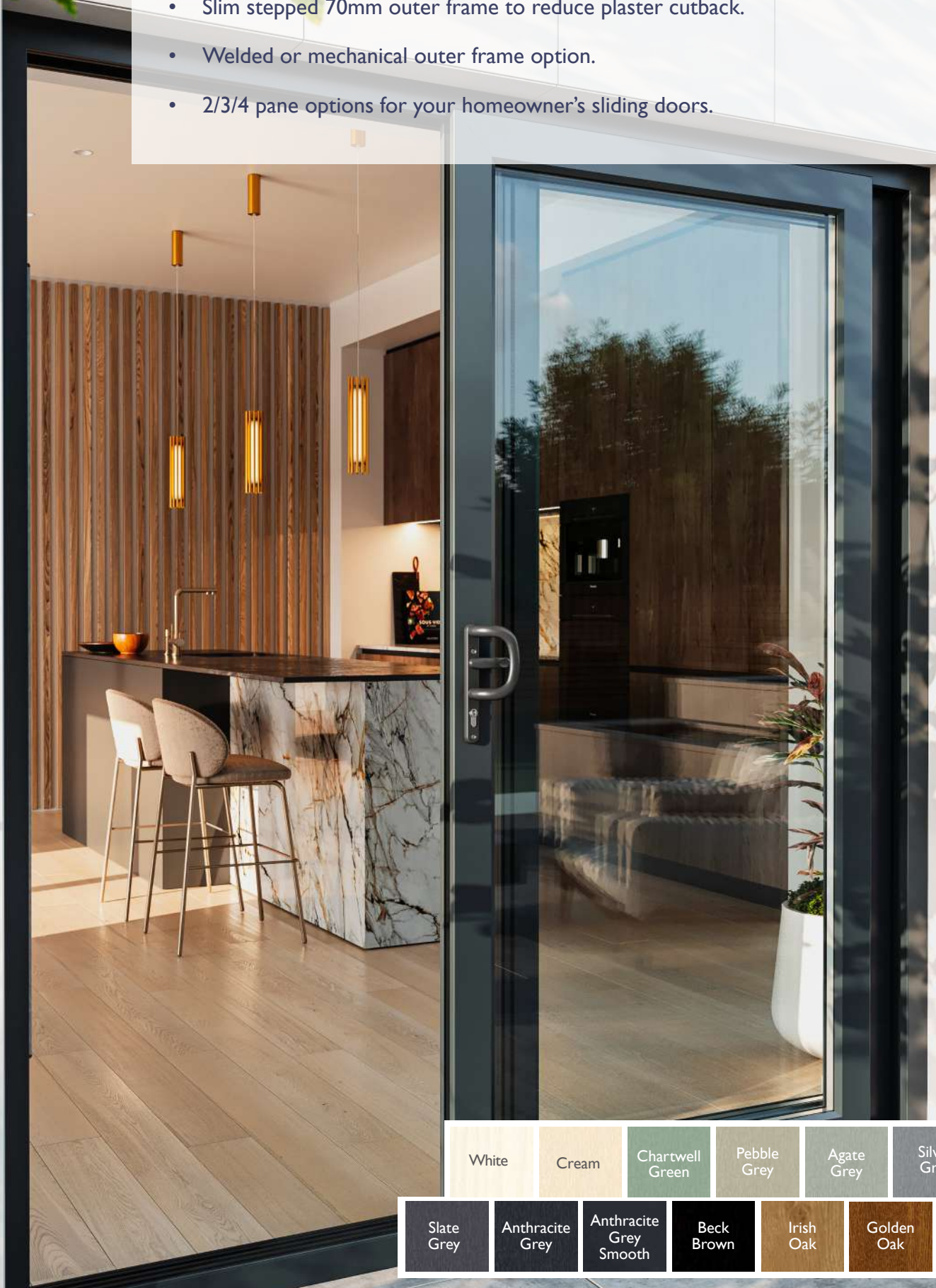

Can't find the colour you are looking for? Ask your sales representative for further options.

DoorCo Composite Doors



- All doors meet the requirements of the current Building Regulations.
- Composite Doors filled with CFC-free polyurethane foam.
- Slam shut lock available.
- All doors are in line with Approved Document Q.
- Developed specifically for the UK market.
- Inner core of LVL encased with composite stiles and rails.
- Slab thickness: 44mm
- Laminated glass as standard.

Styles



Palladio Composite Doors

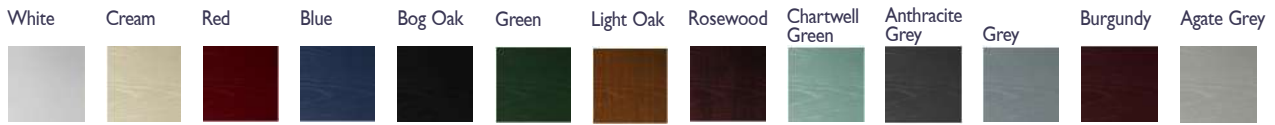

- Looks like a natural wooden door using original mould tooling
- Double rebate using two seals
- 65mm fibreglass reinforced Monocoque Composite Door
- Heritage slam lock
- Triple glazing as standard
- Standard and low thresholds available

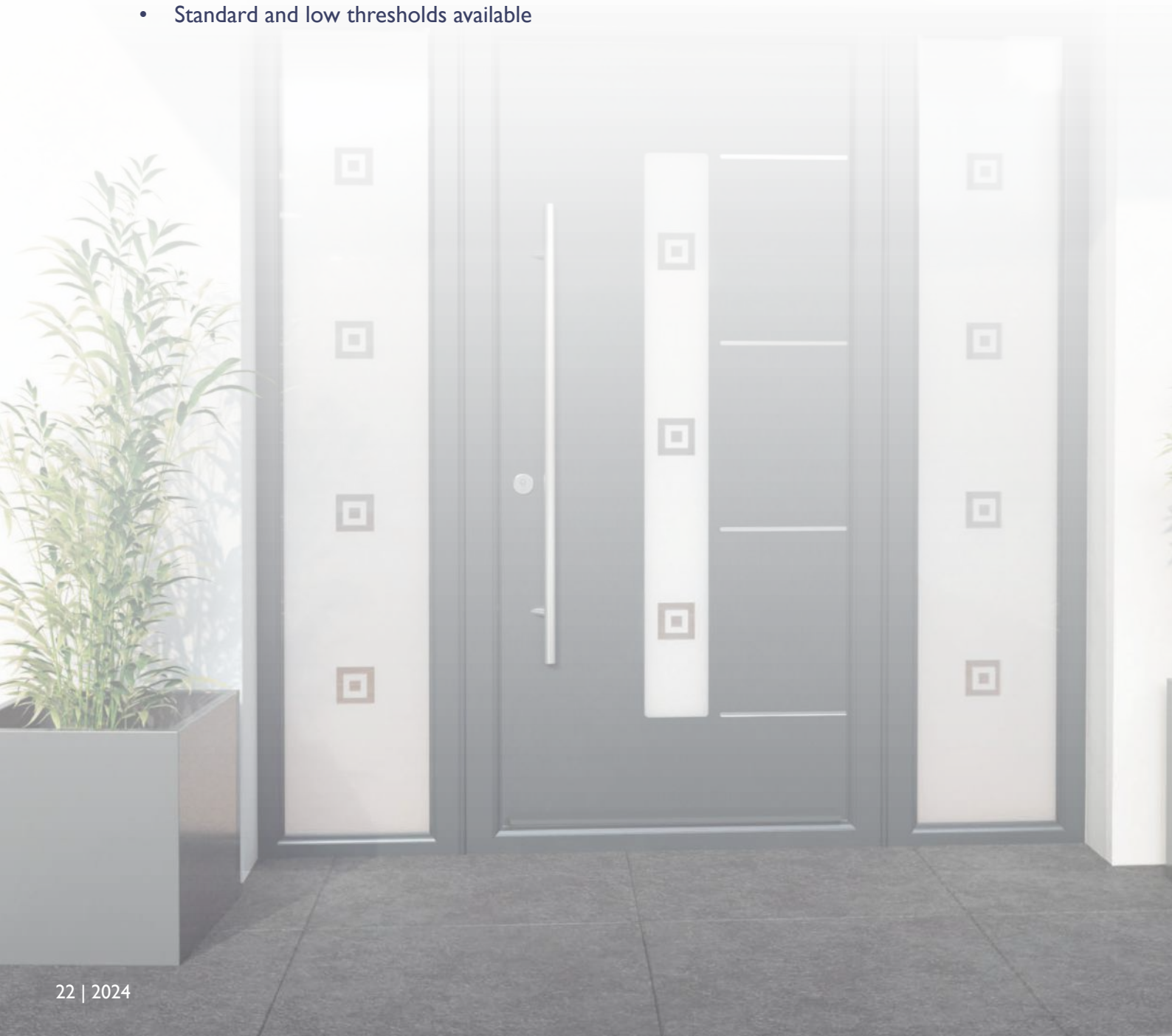

Styles

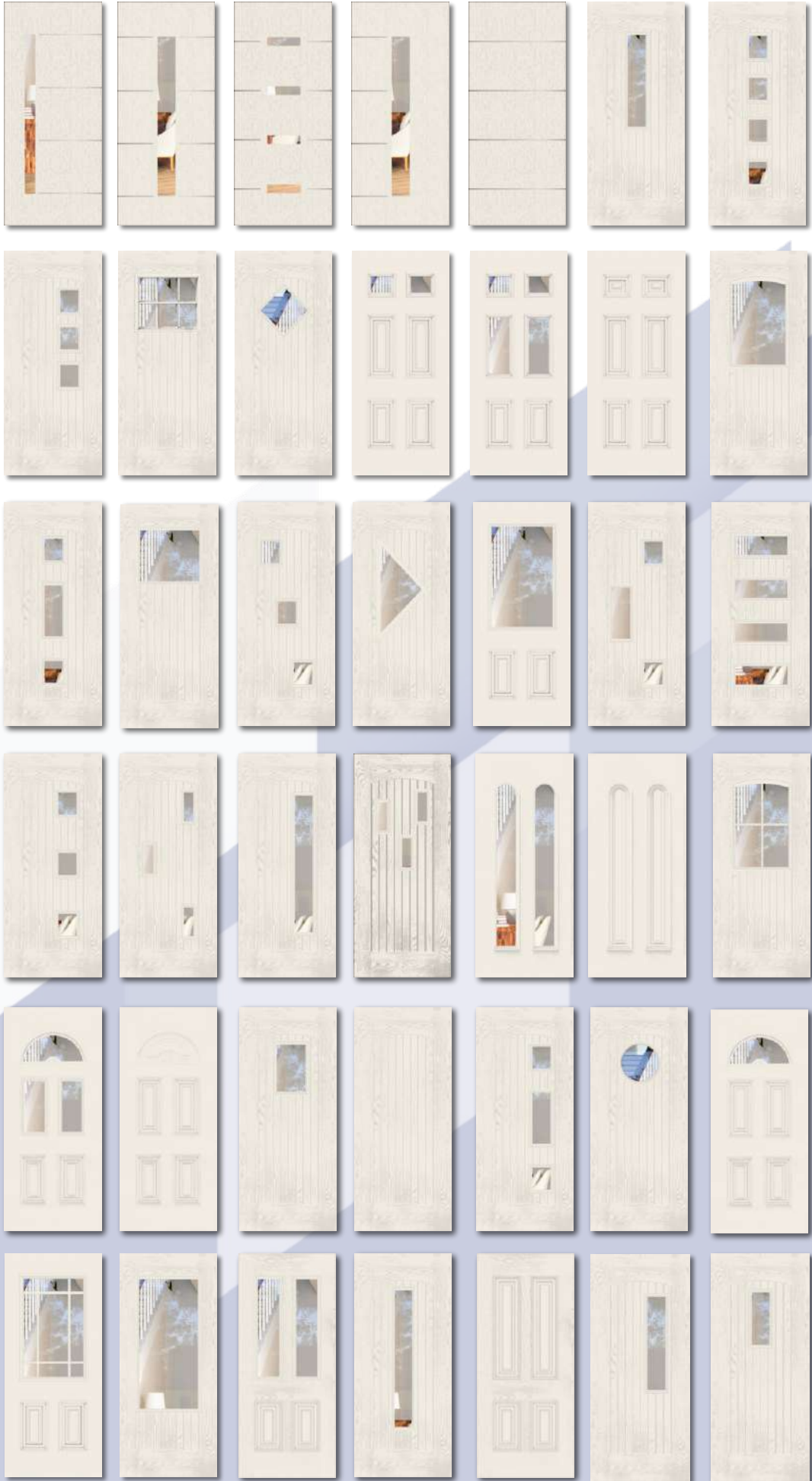

Aluminium Heritage (58BW ST)

- Offered in Square, Putty Line and Stepped Edge aesthetics.
- 58mm or 70mm window system.
- Internally or externally glazed.
- 58mm system offers a slimline 43mm frame.
- Authentic astragal bar available to match heritage aesthetic.



Square



Putty Line



Stepped Edge

Side hung

(Max size): 700w x 1400h

(Min. Size): 450w x 450h (excluding cill)

Top hung

(Max size): 1400w x 1200h

(Min. Size): 450w x 450h (excluding cill)

Sightline (Frame to Vent): 66mm

Sightline (Vent to Vent): 102mm

Sightline (Fixed Light): 43mm



67
colours
to choose from

Aluminium Tilt & Turn (58BW TBT)

Adaptable Aluminium Tilt & Turn Windows

These double glazed windows suit any property type with several opening options providing maximum adaptability for your home.

Ventilation for Your Home

Due to the versatility of our aluminium tilt & turn windows, you'll be able to get the maximum amount of aeration in your home in one smooth action.

Easy Clean Aluminium Windows

Cleaning your home's double glazed windows can be costly and time consuming, but only depending on the style of double glazing you have installed. Aluminium tilt & turn windows are an excellent solution to this, with easy cleaning possible from the inside, helping you save both time and money.

Easy Clean Aluminium Windows

Due to have two functions in the one window style, this allows for ventilation as an option as well as great egress with a 90 degree opening in style. Allowing the end user larger opening areas whilst still having aesthetic and function.



Tilt & Turn

Max Size (mm): 1200w x 2300h

Min. Size (mm): 480w x 575h

Sightline (Frame to Vent): 97mm

Sightline (Vent to Vent): 156mm

Sightline (Fixed Light): 53mm

- Two options available, 58mm or 70mm profile.
- Offered in either bay or contemporary configurations.
- Thoroughly tested for wind and water tightness.
- Open-in option only.

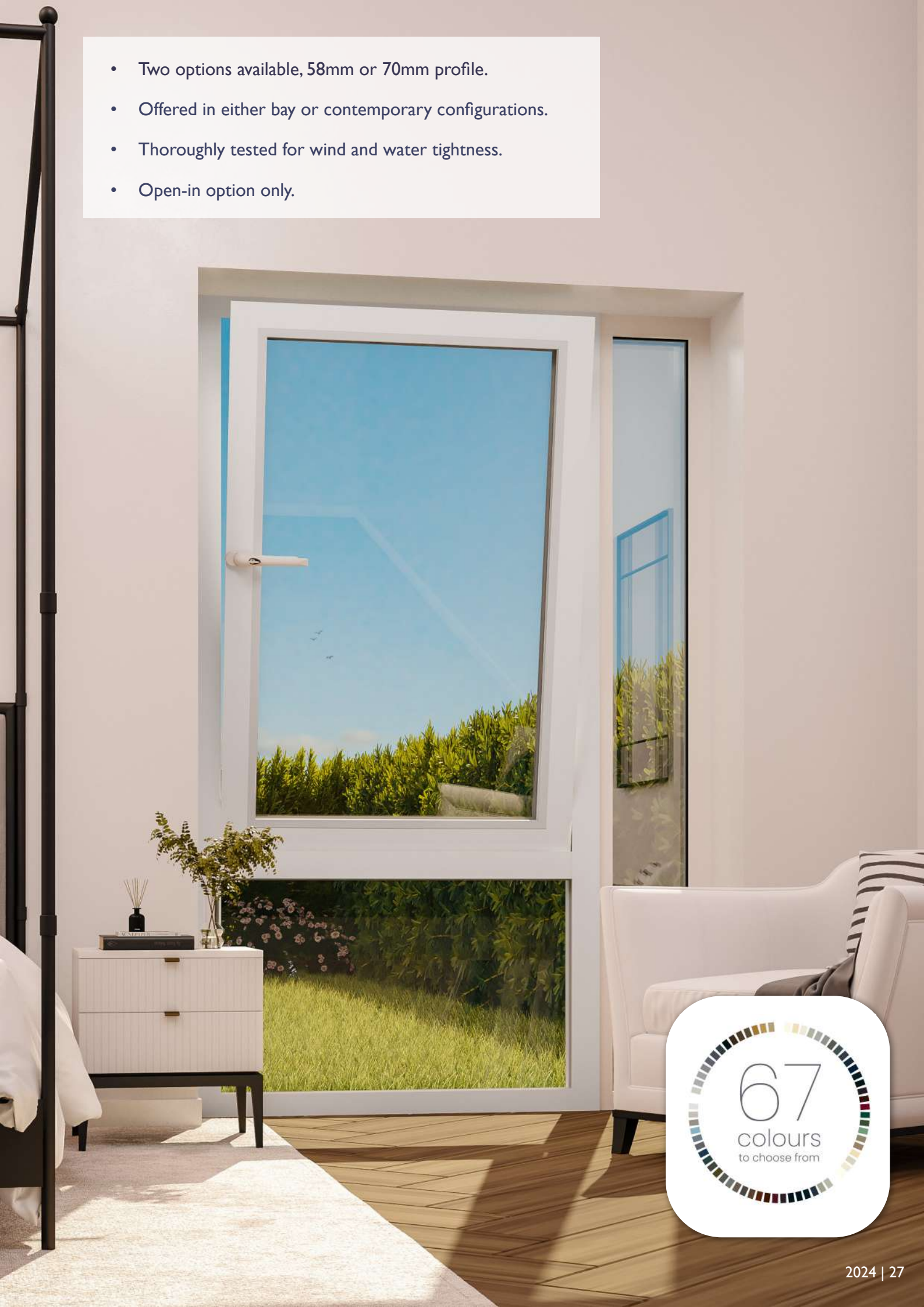

Aluminium Commercial Casement Windows (58BW)

The 58BW window system is built to the highest UK standards and delivers a high-performance and cost-effective solution. This choice of window is perfect for both residential and commercial projects and is available in several formats including Top Hung, Side Hung, and French Casement.

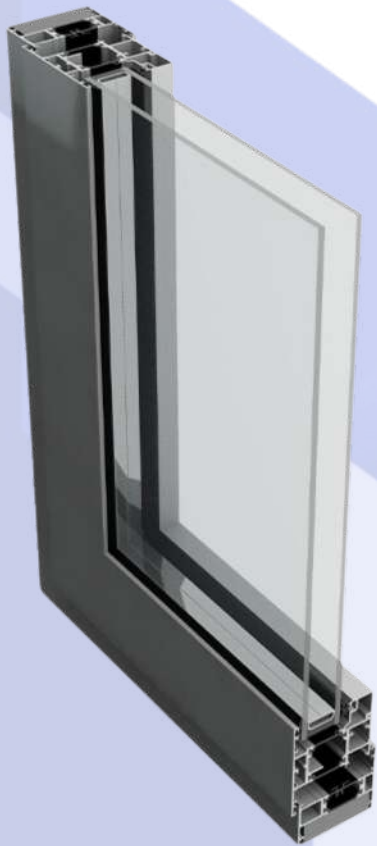

Side Hung

Max Size (mm) 838w x 1500h

Top Hung

Max Size (mm) 1500w x 2500h

Sightline (frame to Vent): 75mm

Sightline (Vent to Mullion): 89mm

Sightline (Fixed Light): 53mm

- Our double glazed windows are made with accuracy at our dedicated Portsmouth factory.
- 58mm or 70mm thick aluminium profile.
- Glazing 28mm-36mm





Aluminium Flush Windows (58BW Flush)

- Our French casement windows achieve U-values as low as 1.4W/m²K.
- A 70mm aluminium frame provides a timeless aesthetic.
- Fully secure with multi point locking systems.
- 75mm edge sight line.



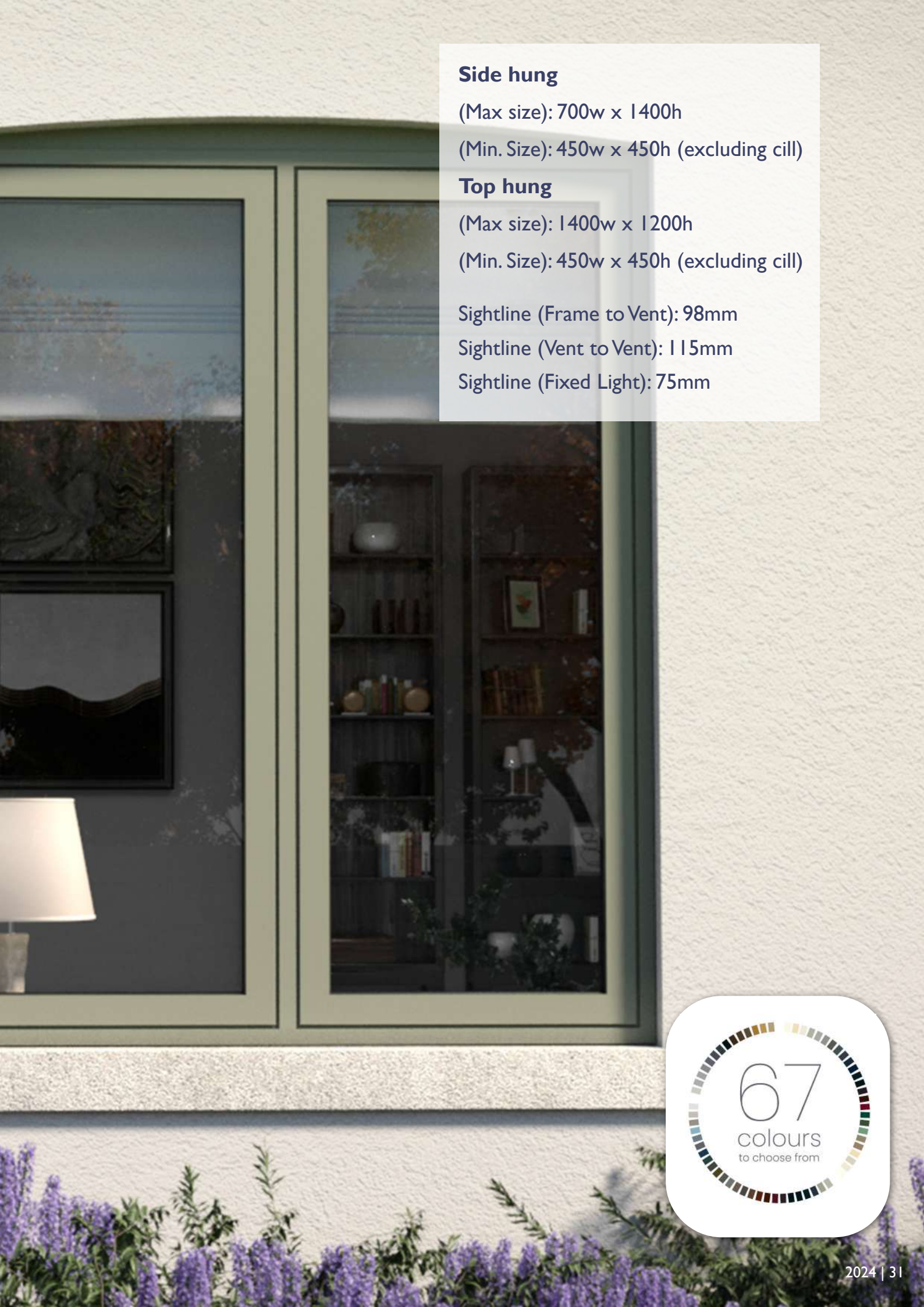

Side hung

(Max size): 700w x 1400h

(Min. Size): 450w x 450h (excluding cill)

Top hung

(Max size): 1400w x 1200h

(Min. Size): 450w x 450h (excluding cill)

Sightline (Frame to Vent): 98mm

Sightline (Vent to Vent): 115mm

Sightline (Fixed Light): 75mm



Aluminium Commercial Shopfronts (GT55 NI/TB)

Ground Floor Treatments Suited to You

Commercial projects often come with tight deadlines, which is something we understand and appreciate at Window Warehouse. We work with you to deliver your commercial aluminium shopfronts rapidly and efficiently.

Maximum Door Leaf size

Single: 1250w x 2400h

Double: 2500w x 2400h

Sightline (Single): 144mm

Sightline (Frame to Pivot Stile): 184mm

Sightline (Double): 176mm

Sightline (GT55 NI Screening): 55mm





- We manufacture insulated high performance aluminium shopfronts. Non insulated systems are available for shopping centres and internal screening.
- Single and double glazing.
- We cater to both new builds and refurbishment projects.
- Tested up to heights of 2400mm.
- Versatility to provide designers with the look, finish, and performance you require.
- Fully mechanised opening system option.
- Anti finger trap as standard.
- 110mm frame depth.



Aluminium (BSF70) Bi-fold Doors

Insulated Aluminium Systems

Homeowners value high levels of protection from outside elements when selecting their home improvements. Our aluminium bifold doors provide perfect water tightness, excellent energy efficiency and burglar resistance to give your home complete protection.

We have a whole factory at our base in Portsmouth, Hampshire dedicated to producing our aluminium products. When handcrafting our bespoke aluminium bifold doors, we ensure the best possible fit of our products in your customer's home.

Upgrade to the Hi System?

You can always upgrade to the Hi system where Aluk have added more innovation to the polyamide thermal break. This is to give much better thermal value whilst not disturbing the finish or aesthetic of their well-known product.

- 70mm aluminium profile thickness.
- Array of configurations.
- Double glazing comes as standard.
- 141mm interlocking system.
- Cornerless post bifold doors available.
- Q Secure Hardware available.
- 3* cylinder as standard.

Max Leaf Height 2400mm

Max Leaf Width 1200mm

Min 600mm width

Sightline (Interlock): 141mm

Sightline (Cill): 131mm

Sightline (Head): 131mm

Sightline (Jamb): 131mm



Configurations

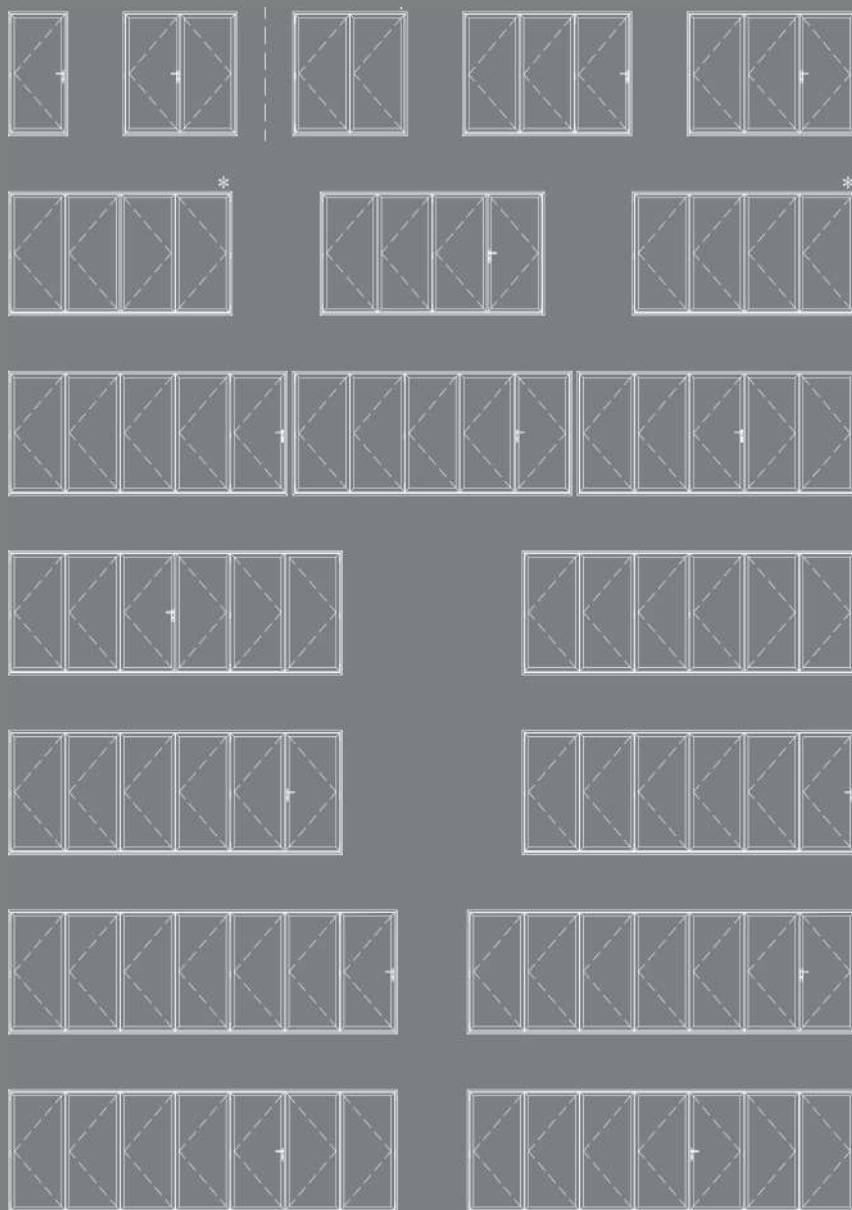

*No external access



Aluminium Patio Doors (BSC94)

- We offer the BSC94 in 'inline' and 'lift and slide'.
- You can choose between double or triple sliding track options.
- Interlock of 85mm with option for slim central interlock of just 44mm for our BSC94 range.



Max Frame Height: 3000mm

Max Vent Width: 2000mm

Max Frame Height With Security Features: 2600mm

Sightline (Interlock): 85mm

Sightline (Head): 116mm

Sightline (Jamb): 116mm

Configurations

Monorail

Applicable for In-Line sliding and Lift & Slide door configurations



Duorail

Applicable for In-Line Sliding and Lift & Slide door configurations

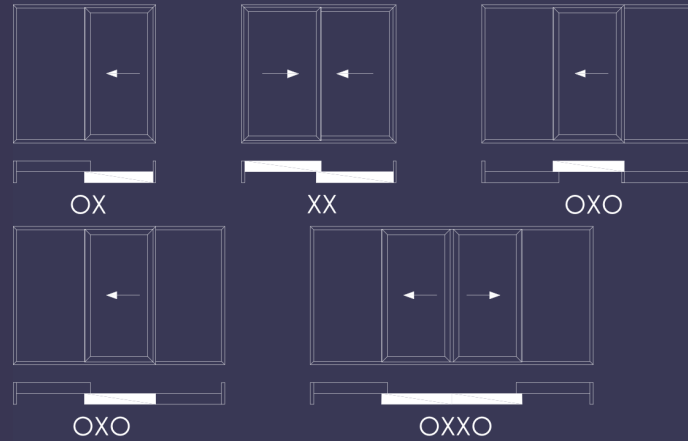

Trirail

Applicable for In-Line sliding door configurations



Aluminium Residential and French Doors (58BD)

- Our aluminium residential doors are available in double or triple glazing.
- Two options available, 58mm or 70mm profile.
- Low threshold options on offer for increased accessibility.
- 28mm-36mm glazing.



Upgrade to the Hi System?

You can always upgrade to the Hi system where Aluk have added more innovation to the polyamide thermal break. This is to give much better thermal value whilst not disturbing the finish or aesthetic of their well-known product.



Max Door Sizes

Single: 1200w x 2400h

Double: 2400w x 2400h

Sightline (Head): 131mm

Sightline (Jamb): 131mm

Sightline (Meeting Stiles): 210mm



Hardware

Inline Espag Handles



Heritage Handles



Offset Espag Handles



Tilt & Turn Window Handles



Lever Door Handles

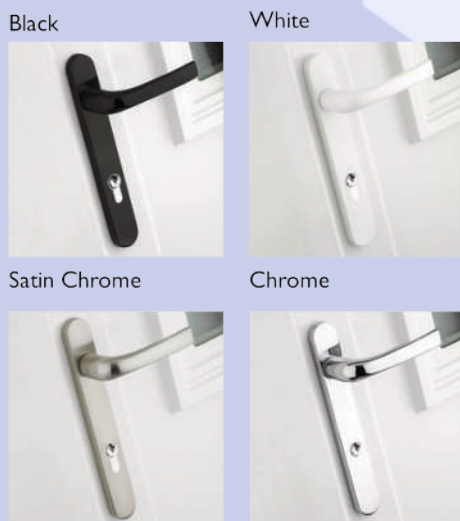

Lever Pad Door Handles



Bifold Door T- Handles Locking & Non- Locking



Composite Door Handles

Escutcheon



Escutcheon Pull



1200 Offset Round Bar



The Offset Round Bar is also available in the following sizes:

- 400mm
- 600mm
- 800mm
- 1000mm
- 1200mm
- 1400mm
- 1600mm

These sizes are available as a single handle or back to back option.

Optional

Knocker



Letterbox



The HI system

Here at Window Warehouse, we offer a range of AluK HI system windows and doors for supply only to trade across the south of England. These innovative products will enhance your product offering. Request a free online quote today to get trade prices on our aluminium HI system profiles. Aluminium is fully recyclable and never losing any structural integrity, truly helping its environmental impact.

Energy Saving Profiles

Each HI system window is manufactured with a Unique polyamide thermal break design to improve thermal performance, providing U-values of $1.2 \text{ W/m}^2\text{K}$. The HI system doors offer U-values as low as $1.4 \text{ W/m}^2\text{K}$. These high-performing features work to trap warm air so you can offer your customers an energy-saving solution.

Installation Simplicity

Each AluK HI system product is easy to install as they are custom-made. With these technological advancements, trade installers can work quickly and efficiently to offer undisturbed installations. When you choose Window Warehouse as your supplier, you will never have to compromise on projects due to our custom-made approach to various applications.

Windows

You are introduced to various profile styles when you use Window Warehouse as your AluK supplier. Our product range includes Optio 58BW Flush HI Window, Optio 58BW Open-Out HI Window, Optio 58BW ST Flush HI Window, Optio 58BW ST HI Window, and Optio 58BWTBT Open In HI Window. Having these five window styles in your product range will allow you to offer customers varied aluminium options in an array of configurations which can be highly customised. The possibilities you can offer are endless.

Our AluK HI system window profiles are built to the highest UK standards. These compelling, high-performance solutions offer clean lines, advanced functionality, and stunning aesthetics.

Doors

Our Optio BSF70 HI Bi-fold and 58BD HI Door Systems are manufactured with style, functionality, and performance in mind. They provide industry-leading U-values, rollers to ensure smooth and consistent operation and larger glazing panels to offer your customers a touch of luxury.

In addition to this, they offer unparalleled innovation and installation ease. These versatile bifold doors can be adapted to suit your and your customer's needs in almost any regard. You can offer each customer various colours, hardware, and panels to reflect their vision. The sash sizes starting from 600mm up to 1200mm.

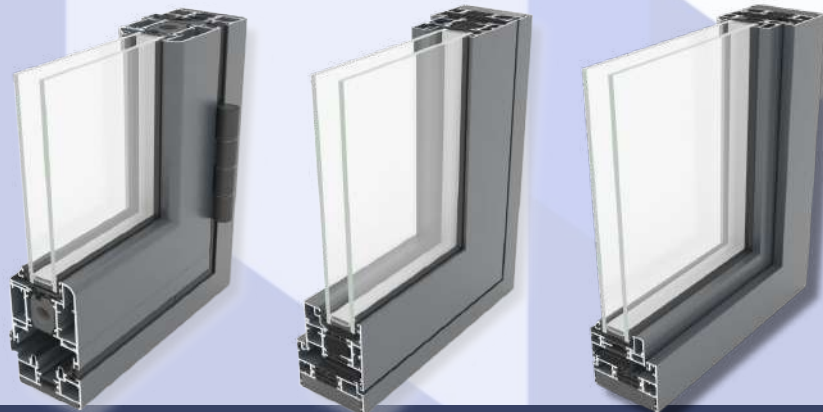
The logo for ALUK, with 'ALU' in black and 'K' in red.

What is the difference between the standard products and the HI system?





Aluk have added more innovation to the polyamide thermal break to give much better thermal value.

Do I have to change the way I install the product?

Enjoy the benefits of lower U-values, all whilst not disturbing the finish, aesthetic, or installation.

Installer's Guide to Part L

Building Regulations were last updated in 2022, with the aim of reducing carbon emissions from new homes by 30% and by 27% for other types of building.

		 L1		 L1		 L2		 L2	
		New Build Dwellings		Existing Dwellings		New Buildings other than Dwellings		Existing Buildings other than Dwellings	
		Notional	Limiting	Limiting		Limiting		Limiting	
Windows	2016	14	2.0	1.6 or WER 'C'		2.2		1.6 or WER 'C'	
	2022	12	16	1.4 or WER 'B'		1.6 or WER 'B*'		1.6 or WER 'B*'	
Doors	2016	14	2.0	1.8 or WER 'E'		2.2		18	
	2022	12	16	1.4 or DSER 'C'		16		16	

AluK's route to meet the new regulations and support our customers has meant engineering many improvements to the internal design without changing the appearance of the systems. Using new thermal break designs and foams, and new gaskets, the well-loved AluK products have been modified to comfortably meet regulations for new build and existing dwellings

Windows and doors installed into a new build are required to be sealed with air sealing tape around the structural openings. Compressible seals or gun sealant may be used to supplement taping. Photographic evidence may be required for sign off.

Installation tolerances are to be in accordance with BS 8213-4 – Windows and Doors – Part 4: Code of practice for the survey and installation of windows and external doorsets. Windows or doors should be located with an overlap between the inner face of the unit and the inner face of the external leaf – for windows an overlap between 30-50mm and for doors 50mm – so that the window or door unit is contiguous with the insulation layer of the external wall.

A fully insulated and continuous cavity closer should be used, installed tight to the insulation and cavity apertures. For door units, install perimeter insulation within the threshold zone or use reinforced cavity closer.

Be sure it's secure with Kubu® Smart Security.

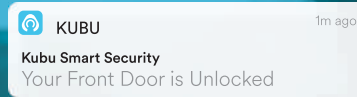

A range of high-security Smart sensors that monitor the status of your doors & windows in real time, alerting you if there's something wrong, and providing you peace-of-mind.

Door Smart Sensors

Our first-of-its-kind door sensor, fits seamlessly into your door lock that 'Works with Kubu®', remaining completely concealed to maintain the aesthetics of the door, while adding the benefits of Smart technology.



Window Smart Sensors

Kubu's Revolutionary 'Floating' Window Sensor is designed to work hand in hand with a multi-point lock that 'Works with Kubu®', to provide second-to-none physical security, with the added benefit of Smart technology.

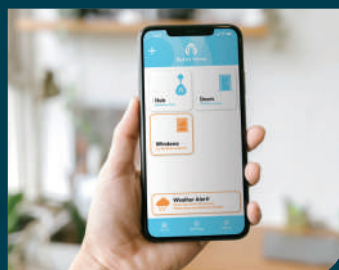

Smart Sensors

- 📶 Completely concealed
- 📶 Calibration FREE
- 📶 Works on ALL doors & windows: lift lever, autofire*, flush, french...
- 📶 Locked/Unlocked Open/Closed/Vent
- 📶 Tamper detection built in



Smart Alerts

- 📶 Instant Status Updates
- 📶 SureSecure™ Geofence Alerts
- 📶 Scheduled Notifications
- 📶 Family Sharing
- 📶 SmartAir/Weather/Pollen Alerts*
- 📶 Under-attack Alerts*

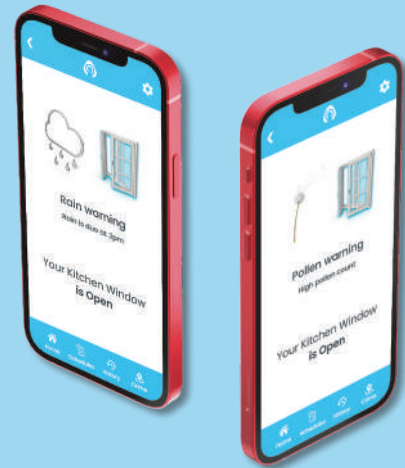

*Coming 2023

Smart Control

- 📶 Fully Smart Home integrated
- 📶 Works with most major smart-tech brands
- 📶 Controlled with the Kubu® smart phone app
- 📶 Activates automations at the turn of a key, or the opening of a window



Smart Benefits

- 📶 10-Year mechanical warranty on all Avantis 'Works with Kubu®' locks
- 📶 World's first Smart Security Guarantee worth £2000!
- 📶 Insurance backed - allows homeowners to save money on their home insurance



All images portrayed in this brochure should not be reproduced without specific written permission from Window Warehouse Ltd. Images, designs and colours are for illustrative purposes only and may differ when manufactured. We reserve the right to amend or withdraw any products within this brochure without prior notice. Colours shown in this brochure should be used for guidance only. Due to the nature of the product it is applied to, there is sometimes a difference between them which we cannot avoid. The colour, intensity and sheen level may differ from the paper print version and we do not accept any liability for this for whatever reason. To ensure that you are getting the right colour on your product, colour swatches are available from our sales team. If you wish to use this brochure for customer support, it's available to be downloaded on our website or you can request printed copies from our marketing team.

Copyright Window Warehouse Limited © 2023

Simply Windows & Doors (Southern) Limited

01730 601340

07454 660770

info@simplydoorssouthern.co.uk